

BIOLUX HCL CONTROL UNIT

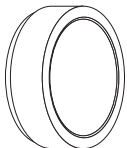

	EAN	d x h [mm]	V _{AC}	Hz	IP	IK	°(°C)	👤
BIOLUX HCL CONTROL UNIT	4058075308657	84 x 54	220-240V	50/60 Hz	20	03	0...+40	0.2 kg

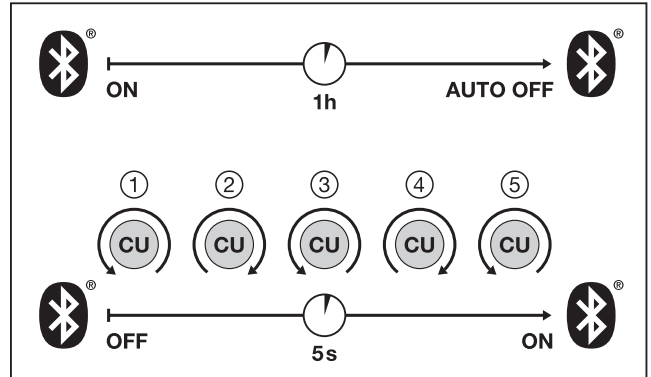
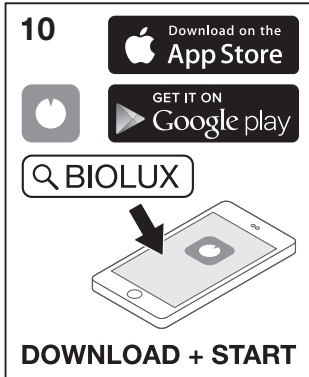
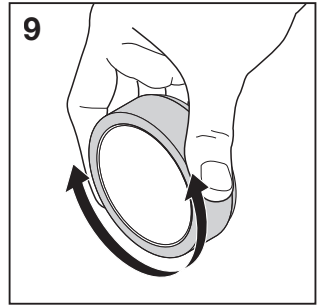
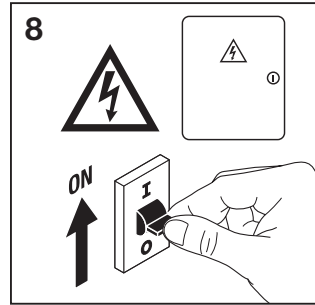
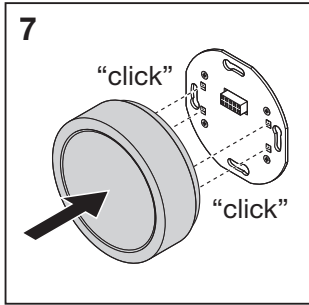
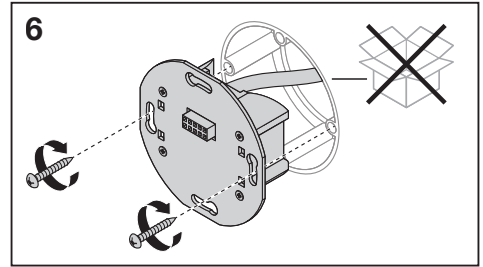
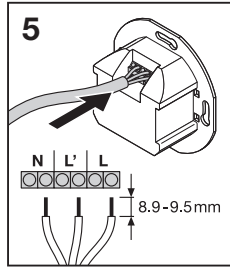
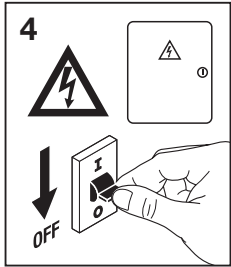
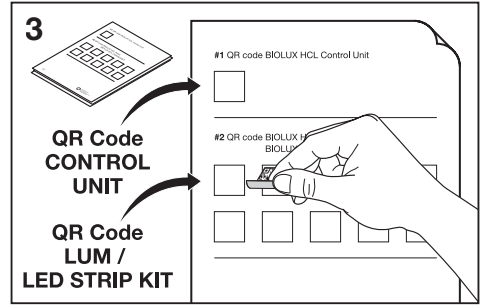

	EAN
BIOLUX HCL PL 625 ZB 43W 2700-6500K	4058075364561
BIOLUX HCL PL 600 ZB 43W 2700-6500K	4058075364547
BIOLUX HCL DL DN150 ZB 20W TW	4058075400733
BIOLUX HCL LS S TW ZB KIT	4058075671270
BIOLUX HCL LS S TW IP67 ZB KIT	4058075671294



CE EAC



C10449058
G11125241
08.07.21



LEDVANCE GmbH
Steinerne Furt 62
86167 Augsburg, Germany
www.ledvance.com